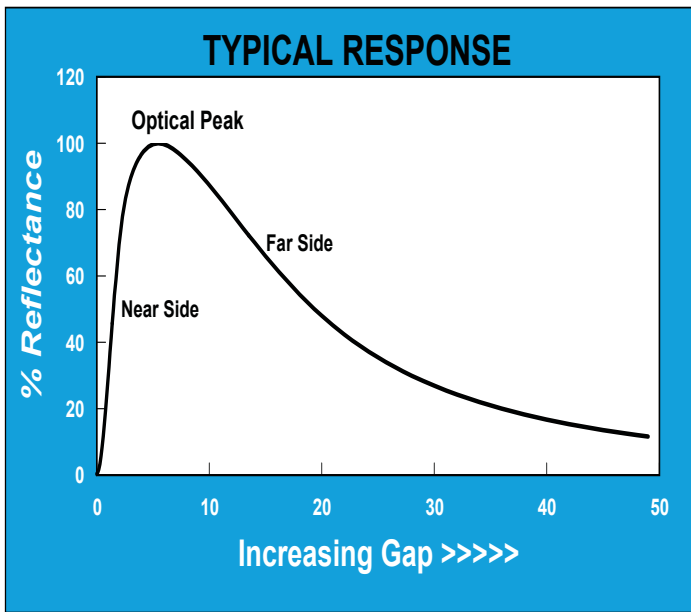
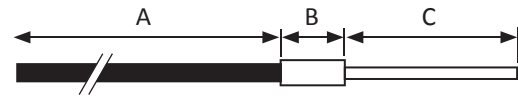

Fiberoptic Sensor - Reflectance Dependent***Model D47**

Fiberoptic Cable & Sensor Tip - Actual Size

**For The Measurement of Distance, Displacement and Vibration****Features**

- Reflectance Dependent Output with Dual Functions: Far Side/Near Side
- \varnothing 1.16 mm Target Spot Size (0.047 inch)
- 5 mm Total Operating Range (0.2 inch)
- 1.6 mv/ μ m Far Side Sensitivity (42 mv/mil)
- 43 mv/ μ m Near Side Sensitivity (1100 mv/mil)

Tip & Cable Dimensions

FEATURE	mm	inch
Tip Outer Diameter, \varnothing C	1.61	0.065
Fiberoptic Diameter	1.16	0.047
Tip Length, C	38.1	1.5
Collar Length, B	12.7	0.5
Collar Diameter, \varnothing B	4.75	0.187
Cable Length, A	914	36
Cable Diameter, \varnothing A	3.34	0.135
Cable Min. Bend Radius	19	0.75

*These are reflective type transducers based upon detecting the intensity of reflected light. The output signal is proportional to:

- the gap distance from the sensor tip-to-target; and,
- the reflectivity of the target surface.

D models are commonly used in applications where the target reflectivity stays constant; i.e., the target has a reciprocating or vibratory motion parallel to the axis of the sensor.

PHILTEC

www.philtec.com

Precision Dynamic Measurements



Two Instrument Outputs To Choose From

This sensor can be provided as an analog or as a digital instrument.

- Model D47 - analog output
- Model DMS-D47 ... standard DMS with RS232 output
- Model mDMS-D47 ... miniDMS with RS232 output
- Model muDMS-D47 ... miniDMS with USB output



Analog sensors are fast responding units ideal for relative motion measurements in dynamic applications:

- DC-20 KHz is standard
- DC-200 KHz or higher is optional
- DC-100 Hz provides best resolution

Standard analog units include:

- Electronics with 0 to +5 VDC output
- 3 foot long fiberoptic cable

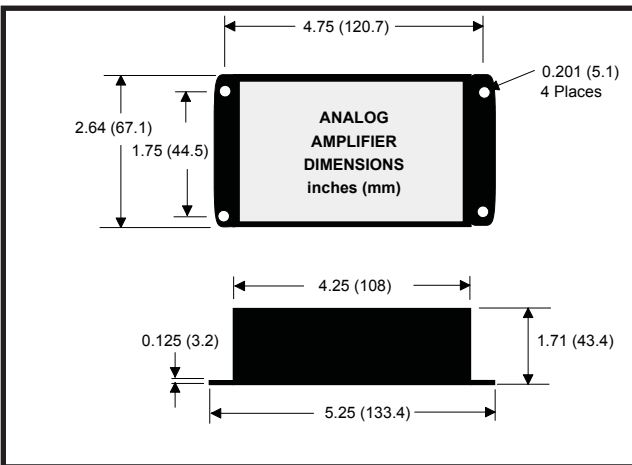

ANALOG OUTPUT

Calibration charts are provided with each sensor tip giving the near and far side voltage output responses to distance. There are three ways to derive accurate distance measurements:

- within the bounds of the linear range, multiply sensitivity by the change in voltage output
- create a lookup table using the XY calibration data points
- use a polynomial curve fit to accurately map the sensor's output function

The effect of changing target reflectance is to shift the voltage output higher or lower. A gain control is provided for calibration of the sensor output to various target surfaces. In-situ calibration is performed simply, by adjusting the sensor's tip-to-target gap until the peak output is attained, and then by using the gain control to set the peak voltage reading to full scale. This allows the sensor to be used to perform precision linear motion measurements on most materials.

Displacement Measurement Systems (DMS) are the best choice for absolute distance measurements, multiplexing and process control applications, with data rates up to 5,000 readings/second. They provide linearized distance output and on board calibration storage capacity for 25 calibrations. Three types are available, each equipped with temperature stabilized electronics:

1. **Standard DMS** units include:

- Electronics with RS-232 communication
- Keypad/LCD for local operation

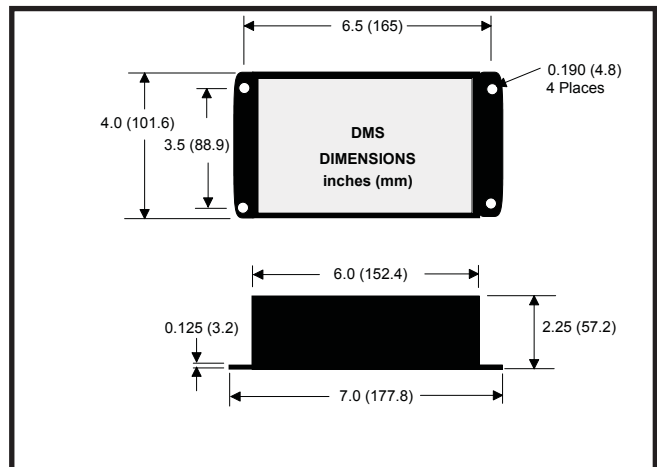

2. **Mini-DMS** units are full-featured for PC operation via RS232 communication, they are not equipped with keypad/display.

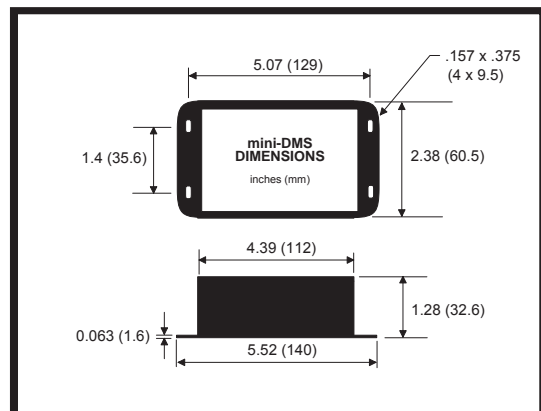

3. **muDMS** units are full-featured for PC operation via USB communication, they are not equipped with keypad/display. They are supplied in the RC analog sensor enclosure, 82 x 111 x 48 mm.

**PHILTEC Model D47
Typical Response - Far Side**

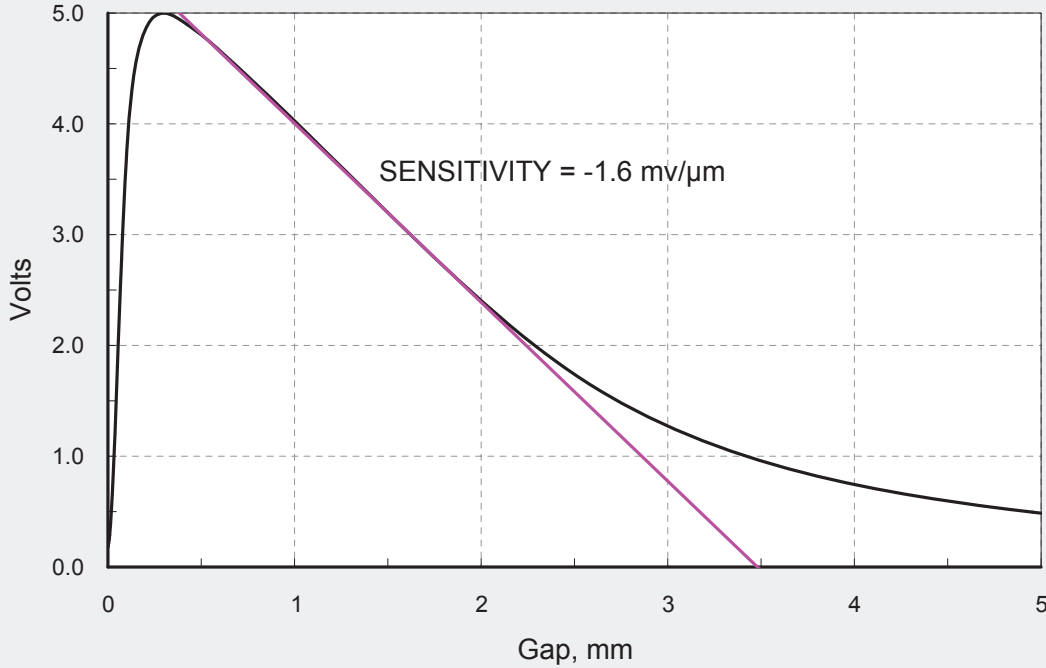

Conversions

- 1 μm = 39.37 μinch
- 1 mm = 39.37 mils
- 1 mil = 0.001 inch
- 1 mil = 25.4 μm
- 1 mil = 0.0254 mm

Standard Specifications - D47 Far Side

Electronics			Fiberoptics		Outputs				
	Analog	DMS	Light Beam Spread	30°	Analog (0-5 Volts)			Digital (USB or RS232)	
Light Source	LED, 880 nm		Cable Sheathing	PVC over Steel Monocoil	Total Range	0.200 in.	5 mm	Total Range	5 mm
Input Voltage	+12 to +24 VDC	+12 VDC	Tip Material	300 Series SS	Linear Range*	0.052 in.	1.3 mm	Linear Range	5 mm
Input Current	125 ma max	500 ma max	Tip Epoxy Outgas	0.3% @ 200°C 2.4% @ 300°C	Nominal Standoff**	0.044 in.	1.1 mm	Reflectance Resolution	0.5%
Band-width	DC-20 KHz 3 db down	5 KHz max	Tip Operating Pressure	35 bar	Nominal Sensitivity*	41 mv/mil	1.6 mv/ μm	Temperature Resolution	0.06°C
Iso-thermal Drift	0.5%	0.05%	Tip Operating Temperature	-55 to 175°C continuous; to 350°C intermittent 1-2 hours	Resolution**	DC - 200KHz DC - 20 KHz DC - 100 Hz	80 μin 40 μin 4 μin	2.0 μm 1.0 μm 0.1 μm	Resolution** Pk-Pk Units at Mid Range using 50% Signal Power ADC AVG = 2 pk-pk = 1.3 μm ADC AVG = 16 pk-pk = 0.9 μm ADC AVG = 256 pk-pk = 250 nm ADC AVG = 4096 pk-pk = 40 nm

*Standard Specifications provide nominal values only. Actual production values may vary by as much as $\pm 15\%$.

**These specifications represent best case performance where: the target is flat, smooth and highly reflective, the sensor is perpendicular to the target, the sensor is gapped to its range of highest sensitivity, fiberoptic cable lengths are standard and the cables are not connectorized.

NOTE: Nominal Standoff = the gap distance that places the sensor at the middle of the linear operating range.

Custom Hardware To Customer Specifications

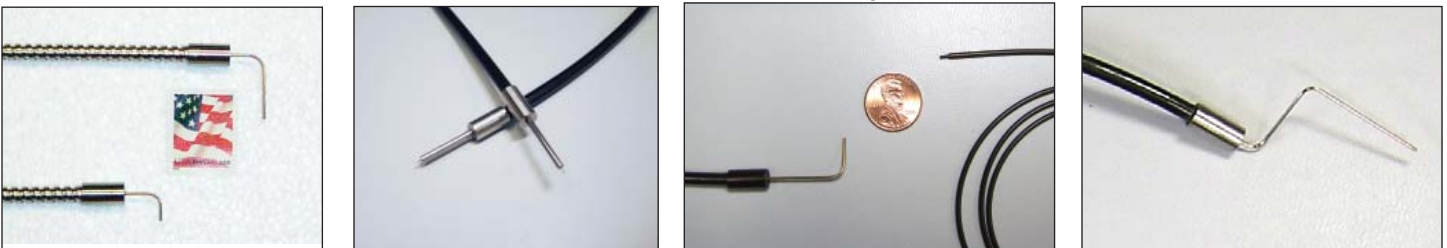

**PHILTEC, INC., ANNAPOLIS, MD USA 410-757-4404
800-453-6242 e-mail sensors@philterec.com**

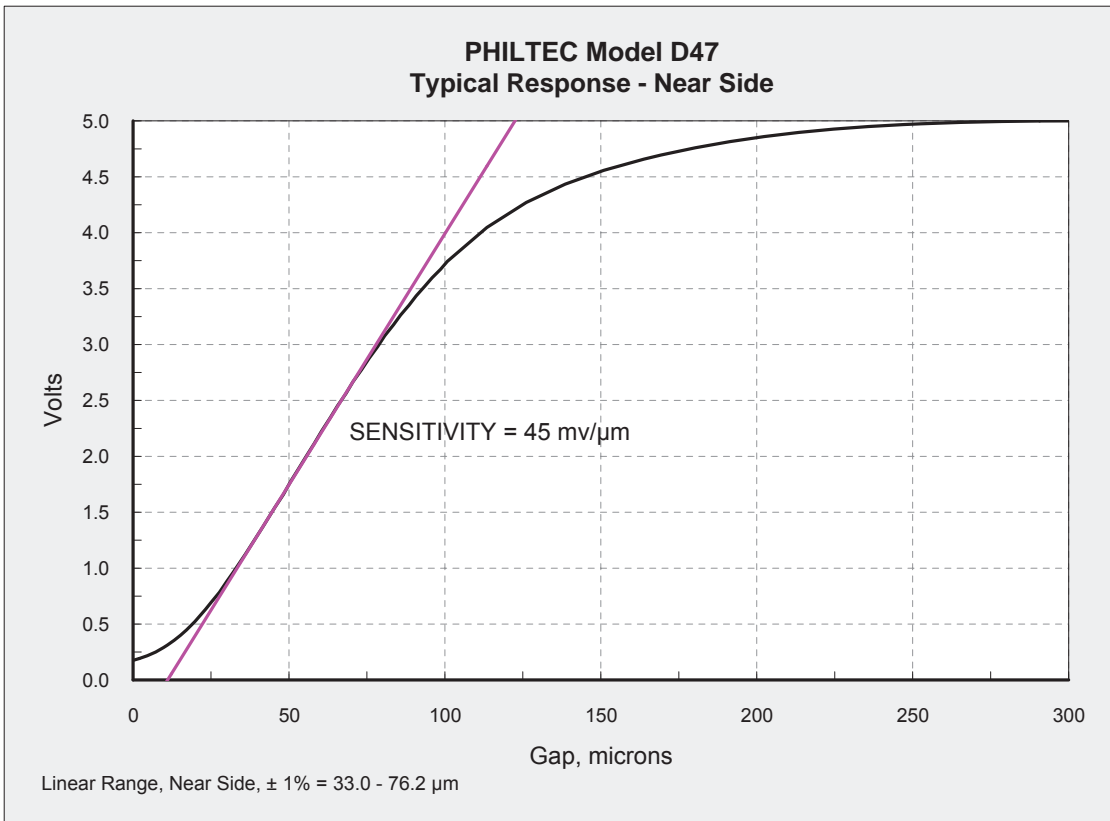

Conversions

- 1 μm = 39.37 μinch
- 1 mm = 39.37 mils
- 1 mil = 0.001 inch
- 1 mil = 25.4 μm
- 1 mil = 0.0254 mm

Standard Specifications - D47 Near Side										
Electronics			Fiberoptics		Outputs					
	Analog	DMS	Light Beam Spread	30°	Analog (0-5 Volts)			Digital (USB or RS232)		
Light Source	LED, 880 nm		Cable Sheathing	PVC over Steel Monocoil	Total Range	12 mils	300 μm	Total Range	300 μm	
Input Voltage	+12 to +24 VDC	+12 VDC	Tip Material	300 Series SS	Linear Range*	1.8 mils	46 μm	Linear Range	300 μm	
Input Current	125 ma max	500 ma max	Tip Epoxy Outgas	0.3% @ 200°C 2.4% @ 300°C	Nominal Standoff*	2.2 mils	56 μm	Reflectance Resolution	0.5%	
Band-width	DC-20 KHz 3 db down	5 KHz max	Tip Operating Pressure	35 bar	Nominal Sensitivity*	1.1 mv/μIN	43 mv/μm	Temperature Resolution	0.06°C	
Iso-thermal Drift	0.5%	0.05%	Tip Operating Temperature	-55 to 175°C continuous; to 350°C intermittent 1-2 hours	Resolution**	DC - 200KHz DC - 20 KHz DC - 100 Hz	4 μin 2 μin 0.6 μin	100 nm 50 nm 15 nm	Resolution**	Pk-Pk Units at Mid Range using 50% Signal Power
									ADC AVG = 2	pk-pk = 50 nm
									ADC AVG = 16	pk-pk = 40 nm
									ADC AVG = 256	pk-pk = 10 nm
									ADC AVG = 4096	pk-pk = 2.5 nm

*Standard Specifications provide nominal values only. Actual production values may vary by as much as ±15%.
 **These specifications represent best case performance where: the target is flat, smooth and highly reflective, the sensor is perpendicular to the target, the sensor is gapped to its range of highest sensitivity, fiberoptic cable lengths are standard and the cables are not connectorized.
 NOTE: *Nominal Standoff = the gap distance that places the sensor at the middle of the linear operating range.*

Many Options are Available Including Replaceable Tips, Vacuum Passthrus and Non-Metallic Tips

